

SERVICE MANUAL

6、 MAIN SPECIFICATION

- 1) Sewing mode: two needle double chain stitching
- 2) Max. Sewing speed: 5500 r.p.m.
- 3) Needle: TV×7 #9-#21
- 4) Stitch length: 1.4mm (1/16")-4mm (5/32")
- 5) Dense seam: by lever
- 6) Needle bar stroke: 30mm
- 7) Needle gauge: 3.2, 4, 4.8, 5.6, 6.4, 8, 9.5, 12.7
- 8) Thread take-up: needle bar thread take-up
- 9) Looper mechanism: adjustable individually and available from 1/8"-1/2"
- 10) Needle protector: with both rocker needle protector and fixed needle protector
- 11) Presser foot lift: 8mm-10mm by knee
- 12) Lubrication: by impeller oil pump
- 13) Lubrication oil: HA-8,HJ-7 machine oil

* The specifications are subject to change without notice.

CAUTIONS

- 1、 Before filling the oil pan with lubrication oil, please do not start the machine.
- 2、 When starting the machine initially, first turn the machine pulley by hand to bring down the needle bar, then turn on the machine to check rotating direction of the machine pulley, making sure the machine pulley rotates counter-clockwise viewing from the machine pulley side.
- 3、 Within the initial month, do not change for a motor pulley with bigger diameter.
- 4、 Please check power voltage and power phase on the motor.
- 5、 When turning on or operating the machine, please do not put your hands near the needle.
- 6、 When turning over the machine head or removing the V-belt, please turn off the machine
- 7、 When the machine is running, please do not put fingers, hair and any objects close to the V-belt, bobbin winder pulley and motor.
- 8、 Please do not operate the machine without belt guard.
- 9、 This machine can sew at 5500r.p.m. and features dense stitches and automatic lubrication with impeller oil pump.
- 10、 Please read this service manual carefully before operation.

CONTENTS

- 1、 MACHINE INSTALLATION
 - 1) OIL PAN INSTALLATION
 - 2) MOTOR PULLEY AND BELT
 - 3) BELT GUARD INSTALLATION
- 2、 MACHINE OPERATION
 - 1) PRECAUTION
 - 2) LUBRICATION
 - 3) NEEDLE THREAD THREADING
 - 4) LOOPER THREAD THREADING
 - 5) THREAD TENSION ADJUSTMENT
 - 6) PRESSER FOOT ADJUSTMENT
 - 7) STITCH LENGTH ADJUSTMENT
 - 8) NEEDLE INSTALLATION
 - 9) SILICON OIL LUBRICATION (OPTION)
- 3、 MACHINE ADJUSTMENT
 - 1) ADJUSTMENT OF PRESSER FOOT AND FEED DOG
 - 2) ADJUSTMENT OF NEEDLE BAR AND NEEDLE
 - 3) TIMING OF NEEDLE AND LOOPER
 - 4) NEEDLE PROTECTOR
 - 5) CAM FOR LOOPER THREAD
 - 6) POSITION FOR THREAD TAKING-UP
 - 7) POSITION FOR INTER-THREAD GUIDE
 - 8) NEEDLE GAUGE CHANGING
- 4、 MACHINE MAINTENANCE
- 5、 TROUBLE SHOOTING AND REMEDY

		6. Improper position of top thread guide on needle bar 7. Needle plate	6. Raise the position of top thread guide on needle bar 7. Use a needle plate with bigger needle hole
4	Needle breaking	1. Needle bent 2. Feed dog and needle not timed 3. Presser foot not installed properly 4. Rocker needle protector not timed 5. Needle thread tension too strong 6. Improper needle	1. Change needle 2. Adjust timing 3. Make sure the hole on presser foot and the hole on needle plate must be aligned with needle center 4. Check timing 5. Loosen tension nut of needle thread 6. Use proper needle as per fabric
5	Puckering	1. Thread tension too strong 2. Looper cam not timed 3. Thread guide not smooth 4. Presser foot pressure too strong	1. Decrease thread tension, especially for looper thread 2. Check timing 3. Abrade thread guide 4. Loosen the adjusting screw of presser foot

3	Poor stitches	2. One stitch skipping (Needle failure to enter into the loop)	1. Check as items 1 and 2 as above 2. Check timing of cam for looper thread 3. Slightly increase looper thread tension 4. Refer to threading method
		3. Incomplete stitches (Needle thread comes in over leftward)	Refer to items 1 and 2
		4. Others (when synthetic thread used)	1. Lower sewing speed 2. Use silicon oil box
		1. Needle thread tension too weak	1. Tighten tension nut of needle thread
		2. Looper thread tension too strong	2. Loosen tension nut of looper thread
3. Looper cam feeding not sufficient	3. Adjust the threading position of looper cam		
4. Thread too thick in relation to needle	4. Change needle		
5. Improper position of inter-thread-guide	5. Lower the position of inter-thread-guide		

1. MACHINE INSTALLATION

1) OIL PAN INSTALLATION

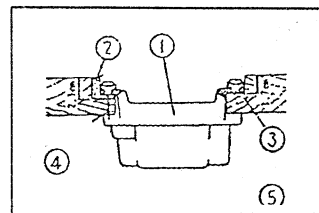

- (1) Oil pan (2) Rubber cushions (3) Rubber cushions
(4) Operator (5) Hinge

Install the oil pan in the cutout of the table top as shown in the figure. Put the rubber cushions in the corners of the table cutout and rest the oil pan on the rubber cushions.

2) MOTOR PULLEY AND BELT

The maximum sewing speed of GK0058 is 5500r.p.m. Please use a clutch motor of 400W only.

- (1) Motor pulley
(2) V-type belt
(3) Diameter

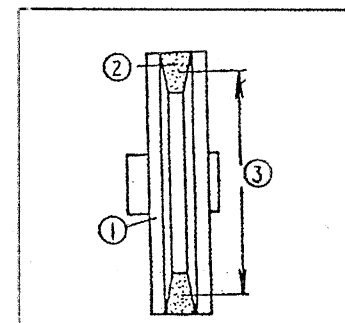

Please always use a V-belt of 42" or 43" and refer to the table of relationship between motor pulley and sewing speed as below.

Frequency	Sewing speed	Motor pulley diameter
50Hz	5500 r.p.m.	φ 130
	5000 r.p.m.	φ 120
	4500 r.p.m.	φ 110
60Hz	5500 r.p.m.	φ 110
	5000 r.p.m.	φ 100
	4500 r.p.m.	φ 90

3) BELT GUARD INSTALLATION

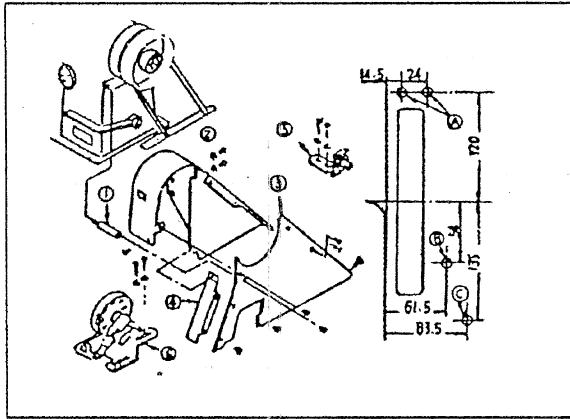

- Drill three holes at A,B,C points on the table.
- Install stud (1) into the hole in the machine head.
- Set temporarily Cover (2) to the machine head with set screws.
- Push the machine head backward slightly and install Cover (3) with four screws by tightening.
- Fix Cover (3) to stud (1).
- Loosen set screws and adjust Cover (2) to the best position, then fasten set screws.

2. MACHINE OPERATION

- PRECAUTION
 - Do not operate the machine before filling oil pan with lubrication oil.
 - The machine pulley should rotate counter-clockwise viewing from the pulley side. Do not run the machine in a wrong direction.
 - For a new machine, be sure not to run the machine at over 4500 r.p.m. in the first month.

5. TROUBLE SHOOTING AND REMEDY

NO.	TROUBLE	CAUSE	REMEDY
1	Thread breaking	1. Poor thread 2. Thread thicker than needle 3. Needle temperature too high 4. Thread tension too high 5. Parts damage (needle, looper, needle plate, needle protector) 6. Thread re-catching	Use quality thread Chang proper thread or needle Use silicon oil box or reduce sewing speed Loosen tension nut Polish with grinding stone. Adjust thread taking-up of needle bar
2	Thread skipping	1. Two stitch skipping (Looper failure to catch)	1. Check thread amount of looper catching 2. Check clearance between needle and looper 3. Check timing of needle and looper 4. Adjust position of inter-thread-guide 5. Adjust thread taking-up position of needle bar as per thread 6. Check needle installation 7. Check timing of rocker needle protector and looper 8. Refer to threading method

8) NEEDLE GAUGE CHANGING

The standard needle gauge is 6.4mm. when changing needle gauge, you must change the following parts accordingly:

- a) needle clamp
- b) presser foot
- c) needle plate
- d) feed dog
- e) rocker needle protector
- f) hemmer

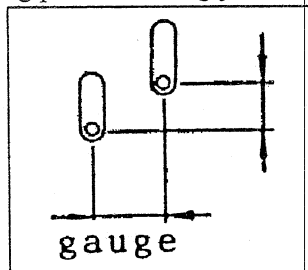

Both right looper and left looper

are available with size from 1/8" to 1/2". If the needle gauge is for larger size, left slide plate and right slide plate should be changed also.

4. MACHINE MAINTENANCE

In order to keep the machine in a good operating condition, please take note of the following:

- 1) Daily checking
 - a) Check the oil sight window to make sure of the proper lubrication.
 - b) If any abnormal noise occurs while operating, contact the mechanic at once.
- 2) Weekly checking
 - a) Remove the needle plate, left slide plate and right slide plate, then clean the dust off the feed dog.
 - b) Clean dust from the filter and oil pan.
 - c) If oil gets dirty, change oil.
- 3) Make sure the oil level in the oil pan should be over Line Low in the oil pan.
- 4) Clean black iron powder from the magnet with soft cloth.

2) LUBRICATION

- a) Before starting the machine, be sure to fill HA-8 or HJ-7 lubrication oil to "HIGH" line marked on the oil pan.
- b) Be sure that oil lever is not below "LOW" line marked on the oil pan.
- c) Oil can be seen spraying from the oil sight window when lubrication is proper.
- d) Change lubrication oil when it gets dirty. Loosen Drain Screw to drain the dirty oil.

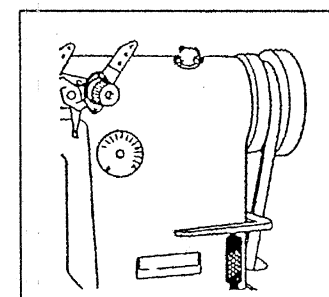
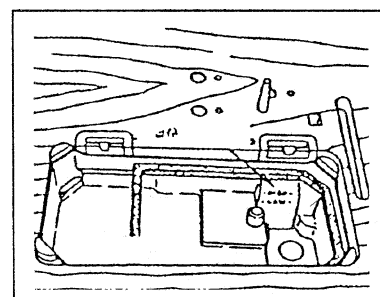

- e) For a new machine or a machine idle for a long time, be sure to lift the presser foot and run the machine idle for 10 minutes at a speed of 3500-4000 r.p.m. for trial running.
- f) When adjusting lubrication for needle bar crank, remove the faceplate, and adjust adjusting screw. Move the indication point on the adjusting screw closest to the crank pin for minimum oil amount and move the point far away from the crank pin for maximum oil amount. Adjust the adjusting screw carefully until the oil amount is changed to satisfaction.

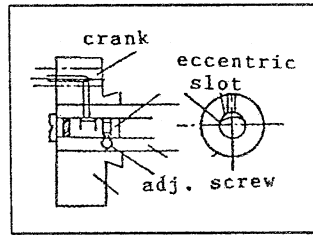
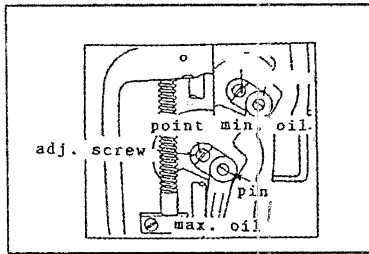

3) NEEDLE THREAD THREADING

Thread the needle thread as shown in the figure, when the needle bar is raised to the highest position:

- a) Thread the needle from the operator side.
- b) Take the thread out of the needle for 10cm long.

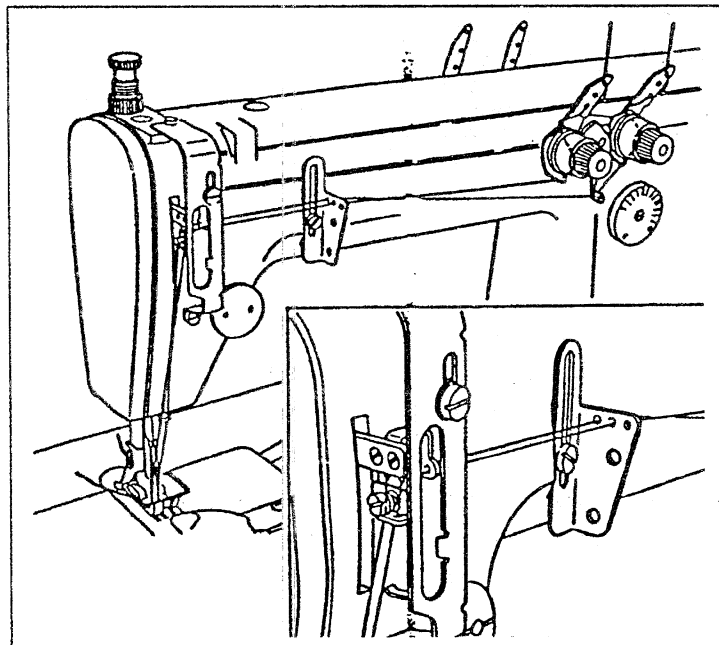

5) CAM FOR LOOPER THREAD

The position of the cam for looper thread should be as shown in the figure. When the needle is lifted to the highest position, the flat side of the cam should be parallel with the wire or slightly above the protruding side. Loosen screw B for adjustment and tighten again after adjusting. When adjusting please check the needle point must enter into the triangle formed by the looper thread completely as the looper thread comes off the protruding side A of the cam.

6) POSITION FOR THREAD TAKING-UP

When thread taking-up of the needle bar is at the lowest position as shown in the figure, the needle thread loop becomes larger and the needle thread loop can be taken in. When using thin thread, lower the thread guide for needle bar to the lowest position.

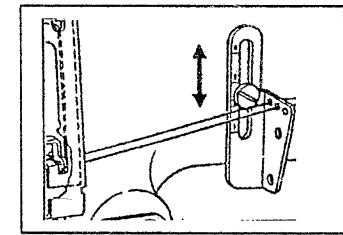
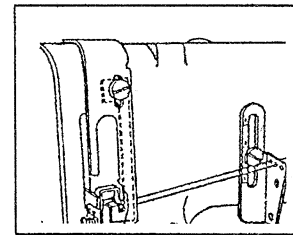

7) POSITION FOR INTER-THREAD-GUIDE

The position for inter-thread-guide sometimes causes thread skipping. Generally use standard positions as follows:

Cotton thread 80#-50#	Position 2-3
Cotton thread 30#-20#	Position 3-4
Synthetic thread 80#-50#	Position 1-2
Synthetic thread 30#-20#	Position 2-3

D. After adjusting looper protector, be sure to check the needle does not touch the looper point. Push the needle slightly by finger. If the clearance is not sufficient, the needle will abrade against the looper, causing damage.

4) NEEDLE PROTECTOR

The timing of rocker needle protector depends on the matching between screw No. 1 and the flat-headed screw as shown in the figure. The right position of rocker needle protector is to keep the needle protector maintained at a proper height and let rocker needle protector brush slightly against the needle when the looper catches thread.

In this case, the distance from the needle to fixed needle protector and rocker needle protector must not be over 0.1-0.2mm. Loosen screw (1) and (2) to adjust the rocker needle protector.

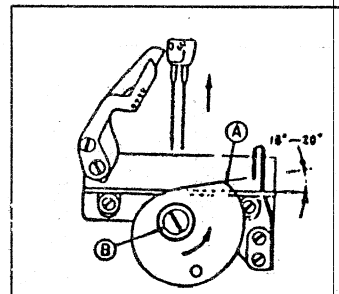
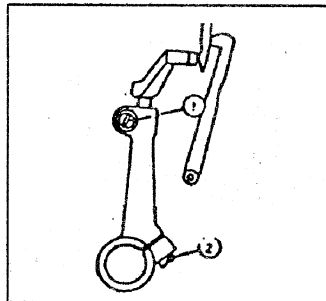
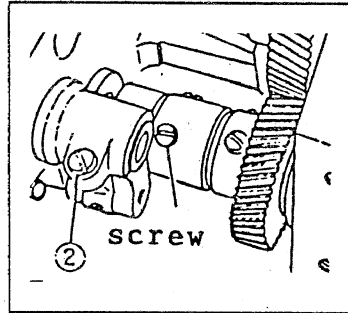

4) LOOPER THREAD THREADING

- a) Thread the looper thread as shown in the figure. Use two holes for strong twisted thread or long stitch length.
- b) Pull the plate spring toward the operator as shown in the figure, and "A" will be lifted up. There are four holes in "A". Use hole (1)(2) for woolen or nylon thread or other stretchy thread or when stitch length is 3mm. Hole (3)(4) are for cotton thread or other less stretchy thread.
- c) When threading loopers use a tweezers in the accessory box and thread as shown in the figure. Pull the thread out of the looper point for 5cm.

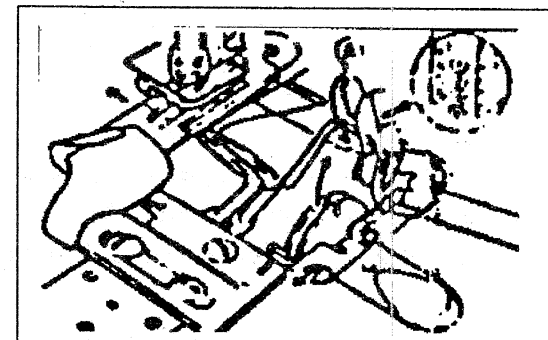
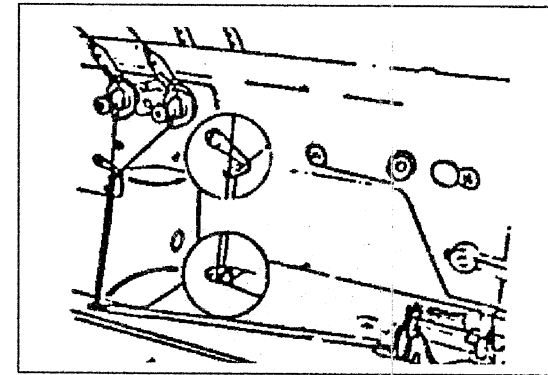

5) THREAD TENSION ADJUSTMENT

Needle thread tension adjustment:

Increase the tension by turning right.

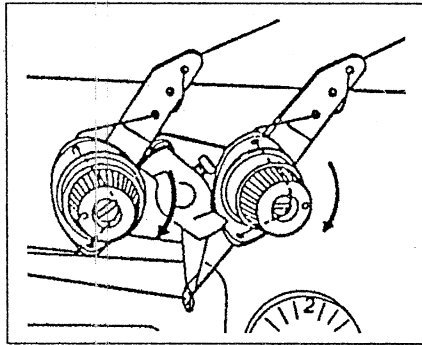

Looper thread tension adjustment:

Increase the tension by turning right.

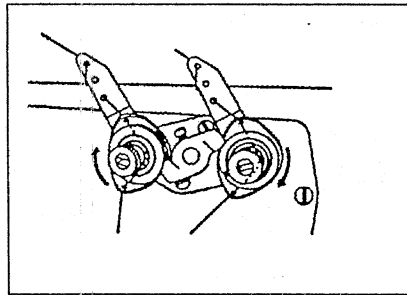

6) PRESSER FOOT ADJUSTMENT

Foot pressure adjustment and presser foot lifting

When the thumb screw is turned right, presser foot pressure will be increased; when the thumb screw is turned left, the pressure will be decreased. A standard pressure should be about 5kg.

B. When the needle comes to the lowest position, the looper mechanism will get to the utmost on the right. This adjustment can be done by loosening gear screws to get the timing of needle and looper.

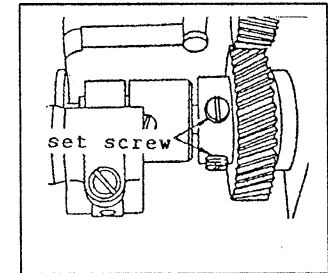
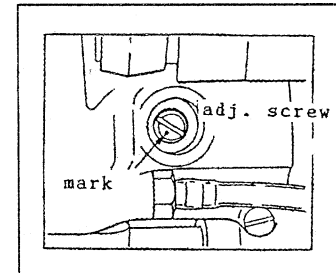

C. When the looper point gets to the centerline of the needle, the standard distance from looper point to the top of the needle hole is 2mm. When the looper point gets to the utmost on the right of the needle centerline, the standard distance from the looper point to the needle centerline is 3.5mm, meanwhile, line 2 marked on the needle bar just coincides with the bottom of the needle bar bushing, as shown in the figure. Both loopers can be adjusted separately.

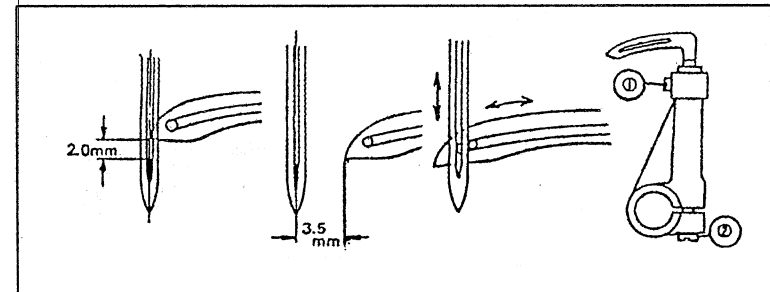

2) ADJUSTMENT OF NEEDLE BAR AND NEEDLE

When using needle (TV × 7) and adjusting the height of needle bar, make sure the mark on the needle bar coincides with the bottom of the needle bar bushing, thus the distance between the needle point and needle plate is 9.5mm.

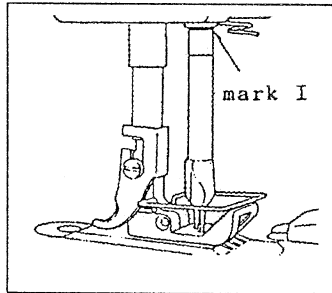

3) TIMING OF NEEDLE AND LOOPER

A. Adjustment of the movement of the looper mechanism depends on "B" size for the elliptical movement of looper mechanism. Generally the maximum "B" size is 3.7mm available for all needle numbers. Adjustment can be proceeded as follows:

- Remove the rubber plug.
- Turn the machine pulley.
- Loosen position screw and flat-headed screw.
- Move the mark on the adjusting screw right, "B" size will be increased.
- Tighten the flat-headed screw and position screw again after adjustment.

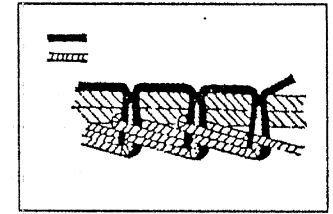
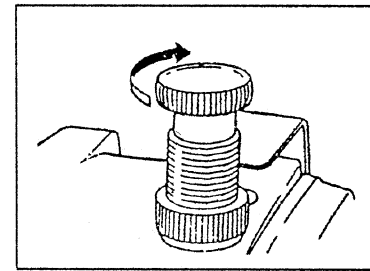
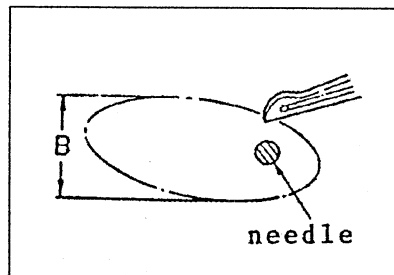

When lifting the presser foot, just turn the presser foot lever left or right.

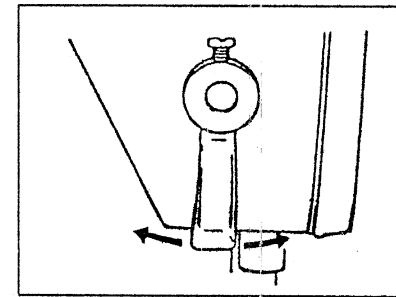

7) STITCH LENGTH ADJUSTMENT

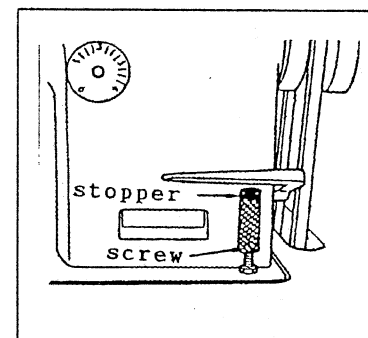

- Stitch dial can be turned left or right.
- Maximum stitch length is 4mm.
- Depress the lever for dense stitching (1.4mm). It is available for seam start and seam end.

8) NEEDLE INSTALLATION

When setting the needle, be sure the needle hole is in accordance with the feeding direction, as shown in figure B.

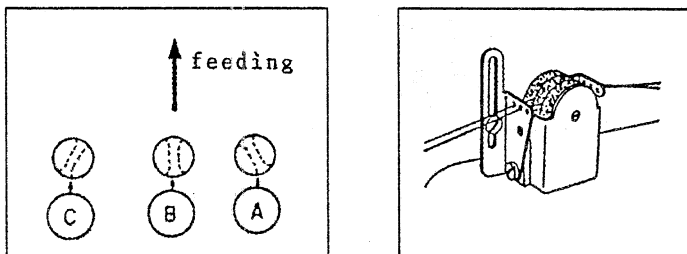

9) SILICON OIL LUBRICATION (OPTION)

A silicon oil lubrication box is available as an option for sewing with synthetic thread. Additional order is required if needed.

3、 MACHINE MAINTENANCE

1) ADJUSTMENT OF PRESSER FOOT AND FEED DOG

A、 Adjust the height of the presser bar

When changing the presser foot, please adjust as follows:

- Remove the rubber plug from the face plate.
- Loosen the set screw for adjusting.
- Tighten the set screw again after adjustment.

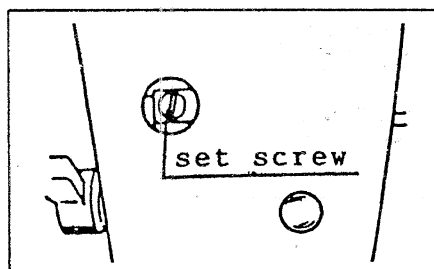

B、 Feed dog installation

Loosen screw (2) as shown in the figure and you can adjust feed dog in Mode A or Mode B, other than the standard mode. The maximum feed dog lift is 0.8mm and can be adjusted by screw (1).

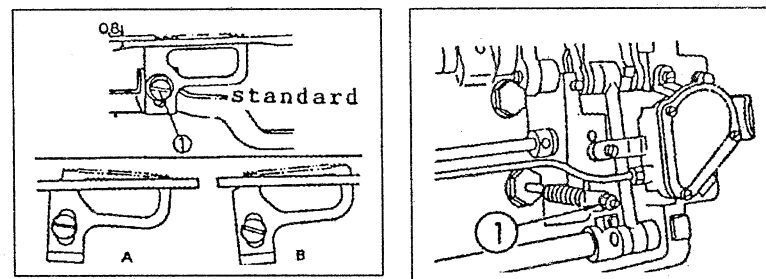

C、 Timing of feed dog and needles

Adjust set screw as shown in the figure, and be sure the feed dog drops completely when the needle point is 3mm from the needle plate.

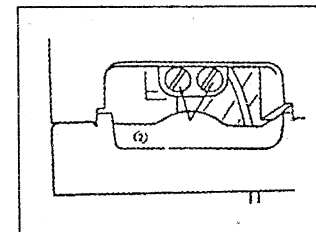

D、 Adjustment of feed connecting rod

When sewing at short stitch length or at low sewing speed, loosen Nut (1) for adjustment, as shown in the figure.

